

快速接頭 Quick Coupling

FU-LOK



快速接頭索引 | Index for Quick Couplings



NL 系列快速接頭
NL Series Quick Couplings

2



KS 系列快速接頭
KS Series Quick Couplings

10



QC 系列快速接頭
QC Series Quick Couplings

15



扣鎖型有耳快速接頭
Camlock Quick Couplings

23

簡介 Introduction

FU-LOK® NL 系列快速接頭採用單閥門設計，適用於一般用途。並依流量大小區分為 NL20(小流量)及 NL40(大流量)兩種。NL20 的母體和子體各尺寸和連接方式均可互換使用，NL40 的母體和子體各尺寸和連接方式亦可互換使用(但 NL20 和 NL40 不能跨種類交叉使用)。

FU-LOK® NL Series Quick Couplings are single valve design for general use. They are divided by flows: NL20 type (low flow) and NL40 type (high flow). Regardless of sizes and connection types, sockets and plugs can be interchangeable within NL20 type and within NL40 type (however, NL20 and NL40 types can not be interchanged between the types).

特色 Features

- 單閥門設計，流體須由母體流向子體
- 適用低壓流體包含：水、空氣
- 本體材質 SS304
- 數種接口型式可依系統需求選用
- 尺寸範圍：1/8" ~ 1"
- 多種墊片材質可選擇
- Single valve design, so the flow must from socket to plug
- Applicable fluids include water and air
- Body material in SS304
- Choice of replaceable end connections provides added system versatility
- Connection in size from 1/8" to 1"
- Variety of packing material for option



NL 系列快速接頭

NL Series Quick Couplings

標準材質結構 Standard Materials of Construction

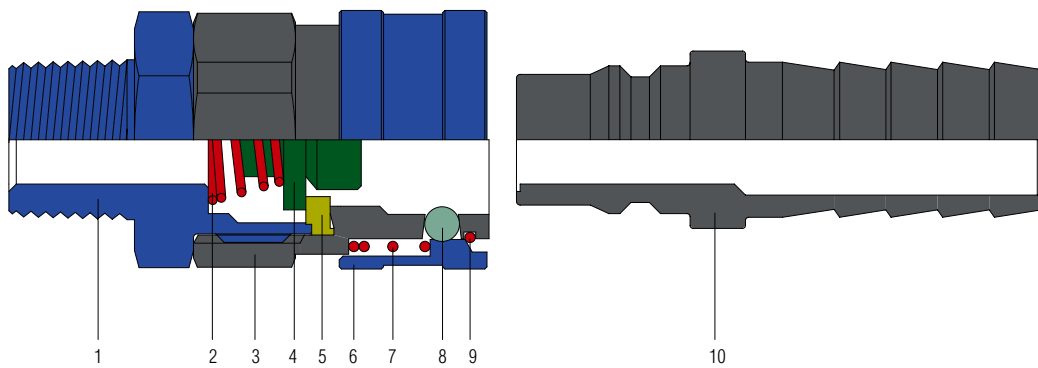

	項次 Item	零件名稱 Components	材質 Material	
母體 Socket	1	母體後套 Socket Adapter	SS304	
	2	閥門彈簧 Valve Spring	SS304	
	3	中體 Socket Body	SS304	
	4	閥門 Valve	SS304	
	5	閥門墊片 Valve Packing	標準 Standard	NBR
			其他選擇 Optional	Viton / EPDM
	6	外環 Sleeve	SS304	
	7	外環彈簧 Sleeve Spring	SS304	
	8	滾珠 Ball	SS304	
9	卡環 Stop Ring	SS304		
子體 Plug	10	子體 Plug	SS304	

NL 系列快速接頭

NL Series Quick Couplings

規格 Specifications

種類 Types		NL20	NL40
連接方式與尺寸 Connection Type and Size	外牙 / 內牙 Male Thread / Female Thread	1/8", 1/4", 3/8", 1/2"	1/2", 3/4", 1"
	膠管 Hose Barb	1/4", 5/16", 3/8", 1/2"	
	卡套接口 Compression End	1/8", 1/4", 3/8", 1/2"	
	軟管用飛速接口 Rapid End	1/4", 5/16", 3/8", 1/2"	-
		φ 4* φ 6, φ 6* φ 8, φ 7.5* φ 10, φ 9* φ 12	
卡套管接口 Tube End	1/4", 3/8", 1/2"		
工作壓力 Working Pressure (kg/cm ²)		15	
墊片材質及 工作溫度範圍 Packing Material and Working Temperature Range	標準 Standard	Buna N (NBR): -20°C ~ +80°C (-4°F ~ +176°F)	
	其他選擇 Optional	Fluorocarbon FKM (Viton): -20°C ~ +180°C (-4°F ~ +356°F) Ethylene Propylene (EPDM): -40°C ~ +150°C (-40°F ~ +302°F)	
適用流體 Applicable Fluid		空氣 / 水 Air / Water	

安全的產品選擇 Safety in Product Selection

管道系統設計師和使用者對於選擇產品負有全責。在選用產品時，需考慮到整體系統的設計、應用細節、材料兼容性、功能、充份的額定值、正確的安裝、操作和維護，以確保安全無故障的性能。

The system designer and user have the sole responsibility for selecting a product for their use. The total system design, application details, material compatibility, function, adequate ratings, proper installation, operation, and maintenance must be considered to ensure safe and trouble-free performance.

NL 系列快速接頭

NL Series Quick Couplings

型號編碼 Part Number Description

Q		S4		SM				24		R			
產品大類 Classification		材質 Material		NL 系列快速接頭樣式 NL Series Quick Couplings				接口尺寸 Connection Size		螺紋種類 Thread Type			
Q	快速接頭類 Quick Couplings	S4	SS304	母體 Socket		子體 Plug		公制 Metric		英制 Fractional		R	BSPT 牙 BSPT Thread
				SM	外牙型 Male Thread	PM	外牙型 Male Thread	6M	6 mm	21	1/8" * 膠管型代表 1/4" 1/4" for hose barb end	N	NPT 牙 NPT Thread
				SF	內牙型 Female Thread	PF	內牙型 Female Thread	8M	8 mm	22	1/4" * 膠管型代表 5/16" 5/16" for hose barb end		
				SH	膠管型 Hose Barb	PH	膠管型 Hose Barb	10M	10 mm				
				SC	卡套接口型 Compression End	PC	卡套接口型 Compression End	12M	12 mm	23	3/8"		
				SN	軟管用飛速接口型 Rapid End	PN	軟管用飛速接口型 Rapid End			24	1/2"		
				ST	卡套管型 Tube End	PT	卡套管型 Tube End	44	1/2"				
				46	3/4"								
48	1"												

NL

母體
Socket

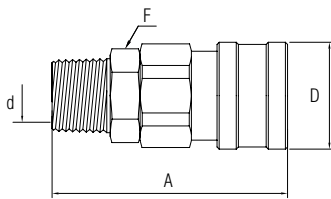

外牙型
Male Thread

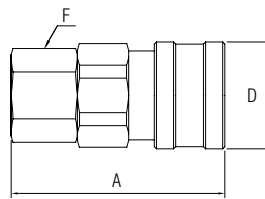

內牙型
Female Thread

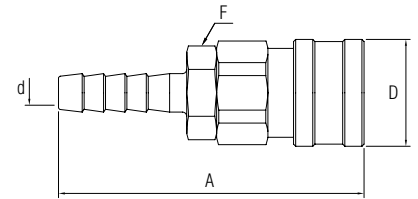

膠管型
Hose Barb

	接口型式 End Connection	種類 Types	尺寸 Size	產品編號 Part No.	尺寸 Dimension			
					A	φ D	φ d	F
SM	外牙型 Male Thread	NL20	1/8"	SM21- □	51.5	25	5	19
			1/4"	SM22- □	54.5	25	7	19
			3/8"	SM23- □	55.5	25	9	19
			1/2"	SM24- □	58.5	25	9	21
		NL40	1/2"	SM44- □	65.0	35	12	30
			3/4"	SM46- □	67.0	35	18	30
SF	內牙型 Female Thread	NL20	1/8"	SF21- □	44.5	25	-	19
			1/4"	SF22- □	50.0	25	-	19
			3/8"	SF23- □	51.0	25	-	21
			1/2"	SF24- □	54.5	25	-	24
		NL40	1/2"	SF44- □	60.0	35	-	30
			3/4"	SF46- □	60.0	35	-	30
SH	膠管型 Hose Barb	NL20	1/4"	SH21	70.5	25	4	19
			5/16"	SH22	71.5	25	5	19
			3/8"	SH23	75.5	25	7.5	19
			1/2"	SH24	75.5	25	9	19
		NL40	1/2"	SH44	82.0	35	9	30
			3/4"	SH46	88.0	35	15	30
			1"	SH48	94.0	35	17	30

- Regardless of sizes and connection types, sockets and plugs can be interchangeable within NL20 type and within NL40 type.
- NL20 and NL40 types can not be interchanged.
- Fill the □ with thread type: "R" for BSPT and "N" for NPT.
- Fraction numbers are in inch size; the others are in mm size.
- Dimensions are for reference only, and are subject to change without notice.

- 無論是哪種連接方式或尺寸，NL20 型的母體和子體各型號可以互換使用，NL40 型的母體和子體各型號也可以互換使用。
- NL20 型和 NL40 型不能互換使用母體與子體。
- 在 □ 中填入螺紋種類：BSPT 牙請填 "R"、NPT 牙請填 "N"。
- 分數的數字單位為英寸 (inch)，其餘的數字單位均為公釐 (mm)。
- 尺寸僅供參考，修改恕不另外通知。

NL

母體
Socket

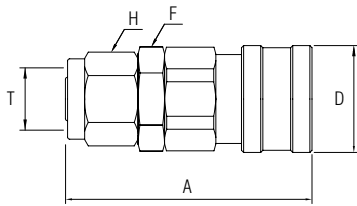

卡套型
Compression End

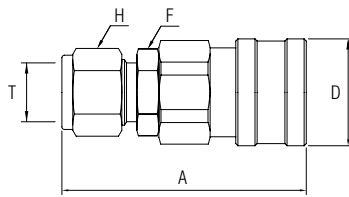

飛速接口型
Rapid End

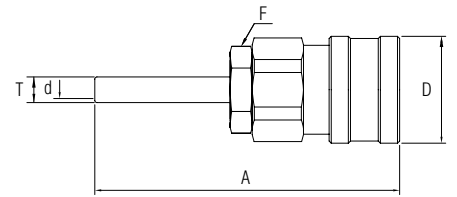

卡套管型
Tube End

	接口型式 End Connection	種類 Types	管子外徑 Tube OD T	產品編號 Part No.	尺寸 Dimension			
					A	φD	F	H
SC	卡套型 Compression End	NL20	1/8"	SC21	58.0	25	19	7/16"
			1/4"	SC22	60.0	25	19	9/16"
			3/8"	SC23	62.0	25	19	11/16"
		NL40	1/2"	SC44	65.0	25	21	7/8"
			3/4"	SC46	74.0	35	30	1-1/8"
			1"	SC48	75.0	35	34	1-1/2"
SN	飛速接口型 Rapid End	NL20	1/4"	SN21	54.0	25	19	12
			5/16"	SN22	55.0	25	19	14
			3/8"	SN23	56.0	25	19	17
			1/2"	SN24	58.0	25	19	19
			6mm	SN6M	54.0	25	19	12
			8mm	SN8M	55.0	25	19	14
			10mm	SN10M	56.0	25	19	17
12mm	SN12M	58.0	25	19	19			

	接口型式 End Connection	種類 Types	卡套管尺寸 Tube		產品編號 Part No.	尺寸 Dimension		
			T	φd		A	φD	F
ST	卡套管型 Tube End	NL20	1/4"	4.3	ST22	62.0	25	19
			3/8"	7.5	ST23	65.0	25	19
			1/2"	10.5	ST24	68.0	25	19

- Regardless of sizes and connection types, sockets and plugs can be interchangeable within NL20 type and within NL40 type.
- NL20 and NL40 types can not be interchanged.
- For compression end and rapid end, the A dimensions is in finger-tight.
- Fraction numbers are in inch size; the others are in mm size.
- Dimensions are for reference only, and are subject to change without notice.

- 無論是哪種連接方式或尺寸，NL20 型的母體和子體各型號可以互換使用，NL40 型的母體和子體各型號也可以互換使用。
- NL20 型和 NL40 型不能互換使用母體與子體。
- 卡套型、飛速接口型的 A 尺寸為用手鎖緊後的尺寸
- 分數的數字單位為英寸 (inch)，其餘的數字單位均為公釐 (mm)
- 尺寸僅供參考，修改恕不另外通知

NL

子體
Plug

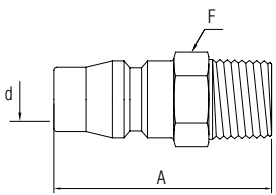

外牙型
Male Thread

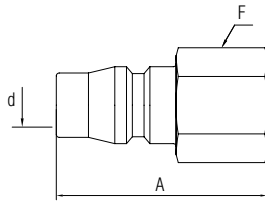

內牙型
Female Thread

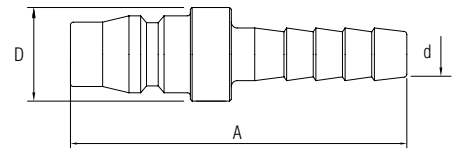

膠管型
Hose Barb

	接口型式 End Connection	種類 Types	尺寸 Size	產品編號 Part No.	尺寸 Dimension		
					A	F/φD	φ d
PM	外牙型 Male Thread	NL20	1/8"	PM21- □	36.5	14	7.5
			1/4"	PM22- □	40.0	14	7.5
			3/8"	PM23- □	41.5	17	7.5
			1/2"	PM24- □	44.5	21	7.5
		NL40	1/2"	PM44- □	48.0	21	12
			3/4"	PM46- □	51.5	27	12
PF	內牙型 Female Thread	NL20	1/8"	PF21- □	33.0	14	7.5
			1/4"	PF22- □	36.0	17	7.5
			3/8"	PF23- □	37.0	19	7.5
			1/2"	PF24- □	40.0	24	7.5
		NL40	1/2"	PF44- □	45.5	24	12
			3/4"	PF46- □	46.0	30	12
PH	膠管型 Hose Barb	NL20	1/4"	PH21	56.5	16	7.5
			5/16"	PH22	57.5	16	7.5
			3/8"	PH23	61.5	16	7.5
			1/2"	PH24	61.5	18	7.5
		NL40	1/2"	PH44	65.0	24	12
			3/4"	PH46	71.0	24	12
			1"	PH48	79.5	30	12

- Regardless of sizes and connection types, sockets and plugs can be interchangeable within NL20 type and within NL40 type.
- NL20 and NL40 types can not be interchanged.
- Fill the □ with thread type: "R" for BSPT and "N" for NPT.
- Fraction numbers are in inch size; the others are in mm size.
- Dimensions are for reference only, and are subject to change without notice.

- 無論是哪種連接方式或尺寸，NL20 型的母體和子體各型號可以互換使用，NL40 型的母體和子體各型號也可以互換使用。
- NL20 型和 NL40 型不能互換使用母體與子體。
- 在 □ 中填入螺紋種類：BSPT 牙請填 "R"、NPT 牙請填 "N"。
- 分數的數字單位為英寸 (inch)，其餘的數字單位均為公釐 (mm)。
- 尺寸僅供參考，修改恕不另外通知。

NL

子體 Plug

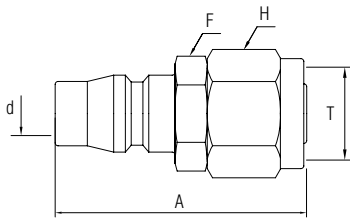

卡套型
Compression End

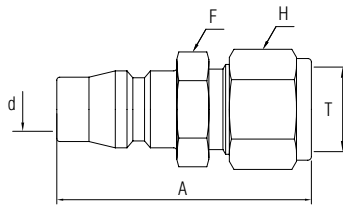

飛速接口型
Rapid End

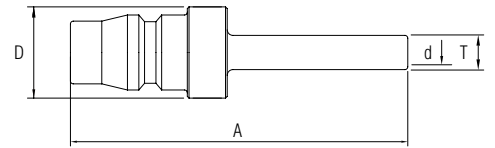

卡套管型
Tube End

	接口型式 End Connection	種類 Types	管子外徑 Tube OD T	產品編號 Part No.	尺寸 Dimension			
					A	F	φ D	H
PC	卡套型 Compression End	NL20	1/8"	PC21	44.0	14	7.5	7/16"
			1/4"	PC22	46.0	14	7.5	9/16"
			3/8"	PC23	48.0	16	7.5	11/16"
		NL40	1/2"	PC44	50.0	21	7.5	7/8"
			3/4"	PC46	55.0	27	12	1-1/8"
			1"	PC48	60.0	35	12	1-1/2"
PN	飛速接口型 Rapid End	NL20	1/4"	PN21	40.0	14	7.5	12
			5/16"	PN22	41.0	14	7.5	14
			3/8"	PN23	42.0	17	7.5	17
			1/2"	PN24	43.0	19	7.5	19
			6mm	PN6M	40.0	14	7.5	12
			8mm	PN8M	41.0	14	7.5	14
			10mm	PN10M	42.0	17	7.5	17
			12mm	PN12M	43.0	19	7.5	19

	接口型式 End Connection	種類 Types	卡套管尺寸 Tube		產品編號 Part No.	尺寸 Dimension	
			T	φ d		A	D
PT	卡套管型 Tube End	NL20	1/4"	4.3	PT22	48.0	16
			3/8"	7.5	PT23	50.0	16
			1/2"	10.5	PT24	54.0	16

- Regardless of sizes and connection types, sockets and plugs can be interchangeable within NL20 type and within NL40 type.
- NL20 and NL40 types can not be interchanged.
- For compression end and rapid end, the A dimensions is in finger-tight.
- Fraction numbers are in inch size; the others are in mm size.
- Dimensions are for reference only, and are subject to change without notice.

- 無論是哪種連接方式或尺寸，NL20 型的母體和子體各型號可以互換使用，NL40 型的母體和子體各型號也可以互換使用。
- NL20 型和 NL40 型不能互換使用母體與子體。
- 卡套型、飛速接口型的 A 尺寸為用手鎖緊後的尺寸
- 分數的數字單位為英寸 (inch)，其餘的數字單位均為公釐 (mm)
- 尺寸僅供參考，修改恕不另外通知

簡介 Introduction

FU-LOK® KS 系列快速接頭為雙閥門設計以減少流體的流失。當母體和子體連接時，母體和子體內的閥門相互推動，流體通道就會開啟；斷開時，母體和子體內的閥門會關閉，各別形成密封。

FU-LOK® KS Series Quick Couplings have twin valve design to eliminate the loss of fluid. When socket and plug are connected, the valves in socket and plug push against each other and open the passage; when the socket and plug are disconnected, both the socket and plug are completely sealed.

特色 Features

- 雙閥門設計，流體可以從母體流入，也可以從子體流入
- 用於中等壓力
- 適用流體包含：水、液壓油、化學藥劑、空氣、蒸氣
- 標準材質 SS304
- 內牙接口型式，尺寸範圍 1/4" ~ 2"
- 多種密封圈材質可選擇

- Twin valve design. Fluid may flow in either direction from socket or from plug side
- For medium pressure use
- Applicable fluids include water, hydraulic oil, chemicals, air, and steam
- Standard material in SS304
- Connection: Female thread in size 1/4" to 2"
- Variety of O-ring material for option



KS 系列快速接頭

KS Series Quick Couplings

標準材質結構 Standard Materials of Construction

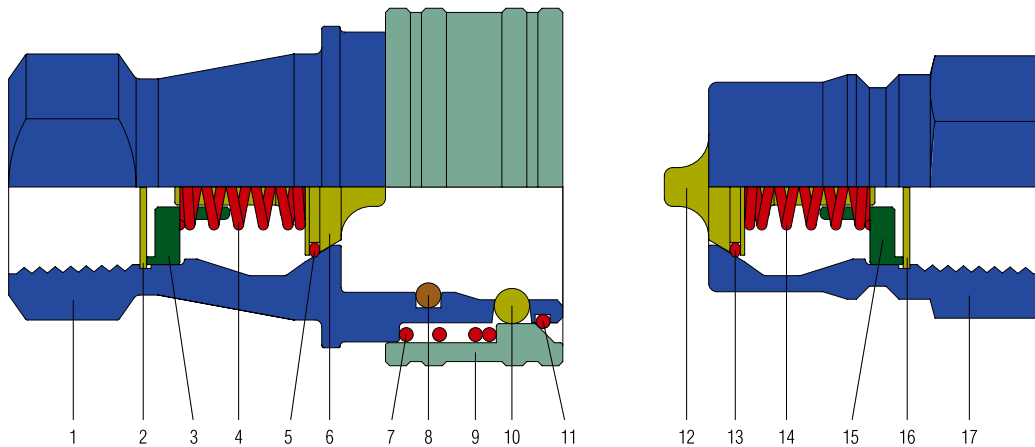

	項次 Item	零件名稱 Components	材質 Material	
母體 Socket	1	母體本體 Socket Body	SS304	
	2	扣環 Snap Ring	SS304	
	3	閥座 Valve Holder	SS304	
	4	閥門彈簧 Valve Spring	SS304	
	5	閥門密封圈 Valve O-ring	標準 Standard	Viton
			其他選擇 Optional	NBR / EPDM / FFKM
	6	閥門 Valve	SS304	
	7	外環彈簧 Sleeve Spring	SS304	
	8	密封圈 O-ring	標準 Standard	Viton
			其他選擇 Optional	NBR / EPDM / FFKM
	9	外環 Sleeve	SS304	
10	滾珠 Ball	SS304		
11	卡環 Stop Ring	SS304		
子體 Plug	12	閥門 Valve	SS304	
	13	閥門密封圈 Valve O-ring	標準 Standard	Viton
			其他選擇 Optional	NBR / EPDM / FFKM
	14	閥門彈簧 Valve Spring	SS304	
	15	閥座 Valve Holder	SS304	
	16	扣環 Snap Ring	SS304	
17	子體本體 Plug Body	SS304		

KS 系列快速接頭

KS Series Quick Couplings

規格 Specifications

連接方式 Connection Type		內牙 Female Thread			
尺寸 Size		1/4", 3/8"	1/2", 3/4", 1"	1-1/4", 1-1/2"	2"
工作壓力 Working Pressure (kg/cm ²)		75	45	30	20
密封圈材質及工作溫度範圍 O-ring Material and Working Temperature Range	標準 Standard	Fluorocarbon FKM (Viton): -20°C ~ +180°C (-4°F ~ +356°F)			
	其他選擇 Optional	Buna N (NBR): -20°C ~ +80°C (-4°F ~ +176°F) Ethylene Propylene (EPDM): -40°C ~ +150°C (-40°F ~ +302°F) Perfluoroelastomer (FFKM): -25°C ~ +250°C (-13°F ~ +482°F)			
適用流體 Applicable Fluid		水 / 液壓油 / 化學藥劑 / 空氣 / 蒸氣 Water / Hydraulic oil / Chemicals / Air / Steam			

安全的產品選擇 Safety in Product Selection

管道系統設計師和使用者對於選擇產品負有全責。在選用產品時，需考慮到整體系統的設計、應用細節、材料兼容性、功能、充份的額定值、正確的安裝、操作和維護，以確保安全無故障的性能。

The system designer and user have the sole responsibility for selecting a product for their use. The total system design, application details, material compatibility, function, adequate ratings, proper installation, operation, and maintenance must be considered to ensure safe and trouble-free performance..

KS 系列快速接頭

KS Series Quick Couplings

型號編碼 Part Number Description

Q		S4		KSP		12		N		E	
產品大類 Classification		材質 Material		KS 系列快速接頭樣式 KS Series Quick Couplings		接口尺寸 Connection Size		螺紋種類 Thread Type		密封圈材質 O-ring Material	
Q	快速接頭類 Quick Couplings	S4	SS304	KSS	母體 Socket	英制 Fractional		R	BSPT 牙 BSPT Thread	V	氟橡膠 Viton
				KSP	子體 Plug	2	1/8"			N	NPT 牙 NPT Thread
		4	1/4"	E	三元乙丙橡膠 EPDM						
		6	3/8"	F	全氟橡膠 FFKM						
		8	1/2"								
		10	5/8"								
		12	3/4"								
		16	1"								
		20	1-1/4"								
		24	1-1/2"								
32	2"										

KS

快速接頭 Quick Couplings

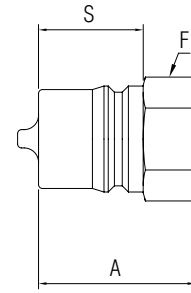
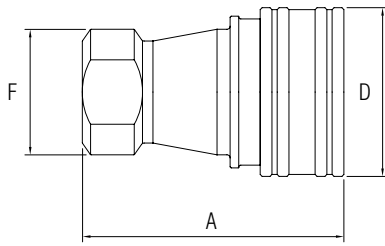

內牙尺寸 Female Thread Size	母體 Socket				子體 Plug			
	產品編號 Part No.	尺寸 Dimensions (mm)			產品編號 Part No.	尺寸 Dimensions (mm)		
		A	D	F		A	S	F
1/8"	KSS2F □	48	24.0	14 x φ 18	KSP2F □	29	19.0	14
1/4"	KSS4F □	58	27.5	19 x φ 22	KSP4F □	36	22.5	17
3/8"	KSS6F □	65	34.5	22 x φ 25	KSP6F □	40	25.0	21
1/2"	KSS8F □	72	44.0	29 x φ 31.5	KSP8F □	44	28.0	27
3/4"	KSS12F □	90	54.5	35 x φ 39	KSP12F □	54	35.5	35
1"	KSS16F □	102	64.0	41 x φ 48	KSP16F □	62	40.0	41
1-1/4"	KSS20F □	112	77.5	54 x φ 59	KSP20F □	70	45.0	54 x φ 59.5
1-1/2"	KSS24F □	124	88.0	63 x φ 69	KSP24F □	75	49.0	63 x φ 69
2"	KSS32F □	132	100	70 x φ 80	KSP32F □	84	50.5	70 x φ 79.5

- Only socket and plug with identical size are able to connect with each other
- Fill the □ with thread type: "R" for BSPT and "N" for NPT.
- Dimensions are for reference only, and are subject to change without notice.

- 只有同尺寸的母體和子體才能一起使用
- 在 □ 中填入螺紋種類：BSPT 牙請填 "R"、NPT 牙請填 "N"
- 尺寸僅供參考，修改恕不另外通知

簡介 Introduction

FU-LOK® QC 系列快速接頭外觀輕巧，適用各種用途。推拉動作即可連結或斷開母體與子體，使得操作上更為簡單快速。雙閥門設計，在母體與子體相連接時打開流體通道，而在母體與子體斷開時關閉流體通道。

FU-LOK® QC Series Quick Couplings are compact and lightweight, suitable for diverse applications. The push-pull action to connect and disconnect enables quick and easy operation. Its DESO (double-end shutoff) design opens the passage when the body (socket) and stem (plug) are connected; the passage closes when the body (socket) and stem (plug) are disconnected.

特色 Features

- 雙閥門設計，以防止流體在快速接頭斷開時洩漏
 - 本體材質 SS316
 - 最大工作壓力 3000 psig (206 bar)
 - 結實的外環可保護母體的開口端
 - 母體的鎖定裝置以大面積固定子體，增加穩定性
 - 數種接口型式可依系統需求選用
 - 尺寸範圍：1/4" ~ 1/2"、6 mm ~ 12 mm
-
- DESO (double-end shutoff) design prevents the leakage when disconnected
 - SS316 material
 - Maximum working pressure up to 3000 psig (206 bar)
 - Heavy-duty sleeve shields the open end of body (socket)
 - The locking device in body (socket) holds stem (plug) with large contact area to increase the stability
 - Choice of replaceable end connections provides added system versatility
 - Size: 1/4" ~ 1/2", 6 mm ~ 12 mm



QC 系列快速接頭

QC Series Quick Couplings

標準材質結構 Standard Materials of Construction

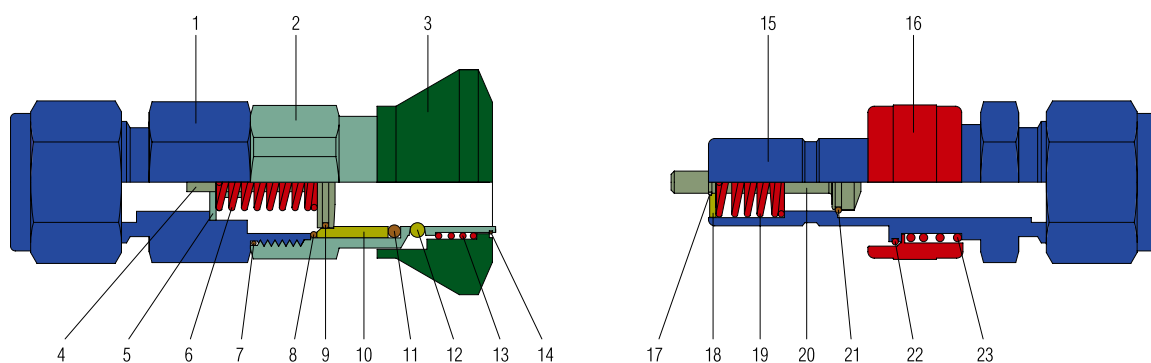

	項次 Item	零件名稱 Components	材質 Material
母體 Body (Socket)	1	母體本體 Socket Body	SS316
	2	中體 Housing	SS316
	3	外環 Sleeve	SS316
	4	閥門 Valve	SS316
	5	閥門彈簧支撐片 Valve Spring Retainer	SS316
	6	閥門彈簧 Valve Spring	SS316
	7	密封圈 O-Ring	Viton
	8	密封圈 O-Ring	Viton
	9	閥門密封圈 Valve O-Ring	Viton
	10	母體插入件 Socket Insert	SS316
	11	密封圈 O-Ring	Viton
	12	滾珠 Ball	SS316
	13	外環彈簧 Sleeve Spring	SS316
	14	外環卡環 Sleeve Stop Ring	SS316
子體 Stem (Plug)	15	子體本體 Plug Body	SS316
	16	外環 Sleeve	SS316
	17	外環卡環 Sleeve Stop Ring	SS316
	18	閥門彈簧支撐片 Valve Spring Retainer	SS316
	19	閥門彈簧 Valve Spring	SS316
	20	閥門 Valve	SS316
	21	閥門密封圈 Valve O-Ring	Viton
	22	外環卡環 Sleeve Stop Ring	SS316
	23	外環彈簧 Sleeve Spring	SS316

QC 系列快速接頭

QC Series Quick Couplings

規格 Specifications

QC Series Quick Couplings Specifications					
連接方式與尺寸 Connection Type and Size	內牙 / 外牙 / 膠管 Female Thread / Male Thread / Hose Barb		1/4"	3/8"	1/2"
	卡套 / 隔板卡套 Compression End / Bulkhead Compression End		1/4", 6mm	3/8", 10mm	1/2", 12mm
工作壓力 Working Pressure (kg/cm ²)	已連結時 Connected	at 21°C (70°F)	206	103	51
		at 180°C (356°F)	17	17	17
	已斷開時 / 正在連接和正在斷開時 Disconnected / While Connecting and Disconnecting		at 21°C (70°F)	17	17
密封圈及閘門墊片材質 O-ring and Valve Packing Material		標準 Standard	Fluorocarbon FKM (Viton): -20°C~+180°C (-4°F~+356°F)		
		選用 Optional	Buna N (NBR): -20°C ~ +80°C (-4°F ~ +176°F) Ethylene Propylene (EPDM): -40°C ~ +150°C (-40°F ~ +302°F) Perfluoroelastomer (FFKM): -25°C ~ +250°C (-13°F ~ +482°F)		
適用流體 Applicable Fluid			空氣 Air		

安全的產品選擇 Safety in Product Selection

管道系統設計師和使用者對於選擇產品負有全責。在選用產品時，需考慮到整體系統的設計、應用細節、材料兼容性、功能、充份的額定值、正確的安裝、操作和維護，以確保安全無故障的性能。

The system designer and user have the sole responsibility for selecting a product for their use. The total system design, application details, material compatibility, function, adequate ratings, proper installation, operation, and maintenance must be considered to ensure safe and trouble-free performance.

QC 系列快速接頭

QC Series Quick Couplings

型號編碼 Part Number Description

Q		S6		QC		10M				BOD		V			
產品大類 Classification		材質 Material		QC 系列快速接頭樣式 QC Series Quick Couplings		接口尺寸 Connection Size				接口種類 Connection Type		密封圈材質 O-ring Material			
Q	快速接頭類 Quick Couplings	S6	SS316	QCS	母體 Socket	公制 Metric		英制 Fractional		MR	BSPT 外牙 BSPT Male Thread	V	氟橡膠 Viton		
						QCP	子體 Plug	6M	6 mm					4	1/4"
								10M	10 mm					6	3/8"
				12M	12 mm			8	1/2"						
				MN	NPT 外牙 NPT Male Thread	N	丁腈橡膠 NBR								
								FR	BSPT 內牙 BSPT Female Thread					EP	三元乙丙橡膠 EPDM
FN	NPT 內牙 NPT Female Thread	F	全氟橡膠 FFKM												
H	膠管型 Hose Barb	OD	卡套型 Compression End												
BOD	隔板卡套型 Bulkhead Compression End														

QC

母體
Socket

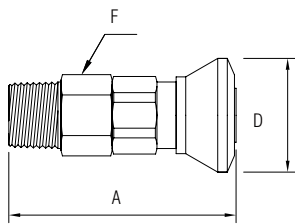

外牙型
Male Thread

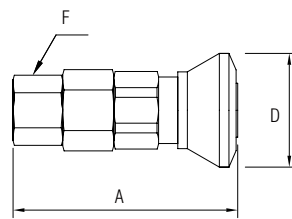

內牙型
Female Thread

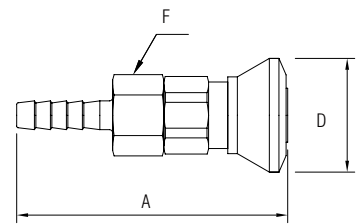

膠管型
Hose Barb

接口型式 End Connection	尺寸 Size	產品編號 Part No.	尺寸 Dimensions (mm)		
			A	φD	F
外牙型 Male Thread	1/4"	QCS4M □	50	22.0	16
	3/8"	QCS6M □	55	25.0	19
	1/2"	QCS8M □	68	29.5	24
內牙型 Female Thread	1/4"	QCS4F □	53	22.0	17
	3/8"	QCS6F □	54	25.0	22
	1/2"	QCS8F □	66	29.5	24
膠管型 Hose Barb	1/4"	QCS4H	63	22.0	16
	3/8"	QCS6H	68	25.0	19
	1/2"	QCS8H	80	29.5	24

- Only socket and plug with identical size are able to connect with each other
- Fill the □ with thread type: "R" for BSPT and "N" for NPT.
- Fraction numbers are in inch size; the others are in mm size.
- Dimensions are for reference only, and are subject to change without notice.
- 只有同尺寸的母體和子體才能一起使用
- 在 □ 中填入螺紋種類：BSPT 牙請填 "R"、NPT 牙請填 "N"
- 分數的數字單位為英寸 (inch)，其餘的數字單位均為公釐 (mm)
- 尺寸僅供參考，修改恕不另外通知

QC

母體
Socket

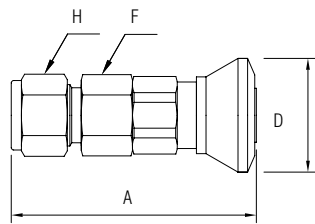

卡套型
Compression End

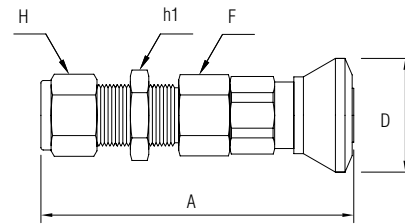

隔板卡套型
Bulkhead Compression End

接口型式 End Connection	尺寸 Size	產品編號 Part No.	尺寸 Dimensions (mm)			
			A	φ D	F	H
卡套型 Compression End	6 mm	QCS6MOD	55	22.0	16	9/16
	10 mm	QCS10MOD	61	25.0	19	19
	12 mm	QCS12MOD	74	29.5	24	7/8
	1/4"	QCS4OD	55	22.0	16	9/16
	3/8"	QCS6OD	61	25.0	19	11/16
	1/2"	QCS8OD	74	29.5	24	7/8

接口型式 End Connection	尺寸 Size	產品編號 Part No.	尺寸 Dimensions (mm)					面板孔徑 Panel Hole Size	最大面板厚度 Max Panel Thickness
			A	φ D	F	H	h1		
隔板卡套型 Bulkhead Compression End	6 mm	QCS6MBOD	71	22.0	16	9/16	16	11.5	10.2
	10 mm	QCS10MBOD	78	25.0	19	19	22	16.2	11.2
	12 mm	QCS12MBOD	93	29.5	24	7/8	24	19.5	12.7
	1/4"	QCS4BOD	71	22.0	16	9/16	16	11.5	10.2
	3/8"	QCS6BOD	78	25.0	19	11/16	19	14.7	11.2
	1/2"	QCS8BOD	93	29.5	24	7/8	24	19.4	12.7

- Only socket and plug with identical size are able to connect with each other
- A is approximate figure in finger-tight
- Fraction numbers are in inch size; the others are in mm size.
- Dimensions are for reference only, and are subject to change without notice.
- 只有同尺寸的母體和子體才能一起使用
- A 尺寸為用手鎖緊的約略數值
- 分數的數字單位為英寸 (inch)，其餘的數字單位均為公釐 (mm)
- 尺寸僅供參考，修改恕不另外通知

QC

子體
Plug

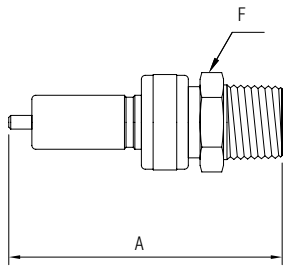

外牙型
Male Thread

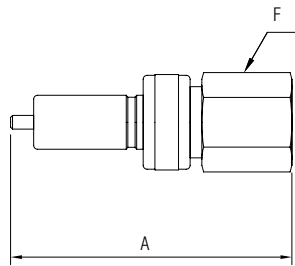

內牙型
Female Thread

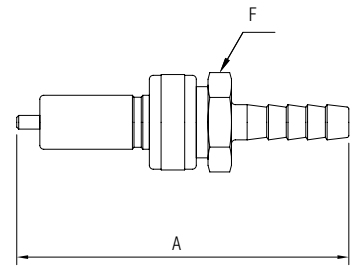

膠管型
Hose Barb

接口型式 End Connection	尺寸 Size	產品編號 Part No.	尺寸 Dimensions (mm)	
			A	F
外牙型 Male Thread	1/4"	QCP4M □	59	14
	3/8"	QCP6M □	60	17
	1/2"	QCP8M □	74	24
內牙型 Female Thread	1/4"	QCP4F □	59	17
	3/8"	QCP6F □	57	22
	1/2"	QCP8F □	70	24
膠管型 Hose Barb	1/4"	QCP4H	68	12
	3/8"	QCP6H	78	14
	1/2"	QCP8H	95	24

- Only socket and plug with identical size are able to connect with each other
- Fill the □ with thread type: "R" for BSPT and "N" for NPT.
- Fraction numbers are in inch size; the others are in mm size.
- Dimensions are for reference only, and are subject to change without notice.
- 只有同尺寸的母體和子體才能一起使用
- 在 □ 中填入螺紋種類：BSPT 牙請填 "R"、NPT 牙請填 "N"
- 分數的數字單位為英寸 (inch)，其餘的數字單位均為公釐 (mm)
- 尺寸僅供參考，修改恕不另外通知

QC

子體
Plug

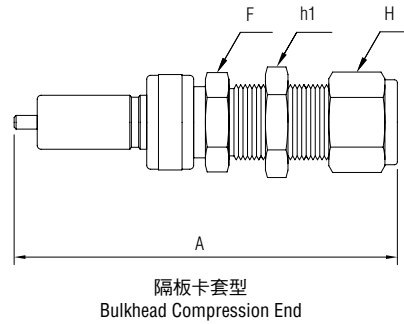
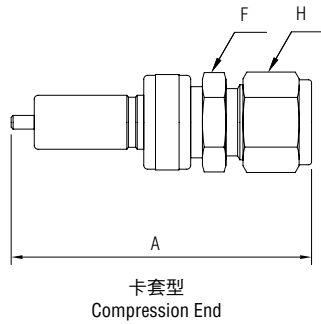

接口型式 End Connection	尺寸 Size	產品編號 Part No.	尺寸 Dimensions (mm)		
			A	F	H
卡套型 Compression End	6 mm	QCP6MOD	64.0	14	9/16
	10 mm	QCP10MOD	63.5	14	19
	12 mm	QCP12MOD	80.0	19	7/8
	1/4"	QCP4OD	64.0	14	9/16
	3/8"	QCP6OD	63.5	14	11/16
	1/2"	QCP8OD	80.0	19	7/8

接口型式 End Connection	尺寸 Size	產品編號 Part No.	尺寸 Dimensions (mm)				面板孔徑 Panel Hole Size	最大面板厚度 Max Panel Thickness
			A	F	H	h1		
隔板卡套型 Bulkhead Compression End	6 mm	QCP6MBOD	80	16	9/16	16	11.5	10.2
	10 mm	QCP10MBOD	84	22	19	22	16.2	11.2
	12 mm	QCP12MBOD	99	24	7/8	24	19.5	12.7
	1/4"	QCP4BOD	80	16	9/16	16	11.5	10.2
	3/8"	QCP6BOD	84	19	11/16	19	14.7	11.2
	1/2"	QCP8BOD	99	24	7/8	24	19.4	12.7

- Only socket and plug with identical size are able to connect with each other
- A is approximate figure in finger-tight
- Fraction numbers are in inch size; the others are in mm size.
- Dimensions are for reference only, and are subject to change without notice.
- 只有同尺寸的母體和子體才能一起使用
- A 尺寸為用手鎖緊的約略數值
- 分數的數字單位為英寸 (inch)，其餘的數字單位均為公釐 (mm)
- 尺寸僅供參考，修改恕不另外通知

簡介 Introduction

FU-LOK[®] 扣鎖型有耳快速接頭採用無閥門設計，適用於大流量流體。只要將母體兩邊把手扣上即可連結母體和子體，不需任何工具。

FU-LOK[®] Camlock Quick Couplings are valveless design, suitable for high flow fluid. Just pull down the arms to assemble coupler and adapter, no special tools required.

特色 Features

- 無閥門設計，流體可以從母體流入，也可以從子體流入
 - 滿足低壓大流量需求
 - 適用流體：水、液壓油、空氣、蒸氣、粉末
 - 本體材質 SS316、SS304、鋁、砲金銅、塑膠
 - 數種接口型式可依系統需求選用
 - 尺寸範圍：1/2" ~ 6"
 - 多種墊片材質可選擇
 - 可選配安全插梢及鏈條
-
- Valveless design. Fluid may flow in either direction from socket or from plug side
 - Satisfy low pressure and bulk flow request
 - Applicable fluids include water, hydraulic oil, air, steam, and powder
 - Body materil in SS316, SS304, aluminium, bronze and Polypropylene
 - Choice of replaceable end connections provides added system versatility
 - Connection in size from 1/2" to 6"
 - Variety of gasket material for option
 - Accessories: Safety pin and chain



扣鎖型有耳快速接頭 Camlock Quick Couplings

標準材質結構 Standard Materials of Construction

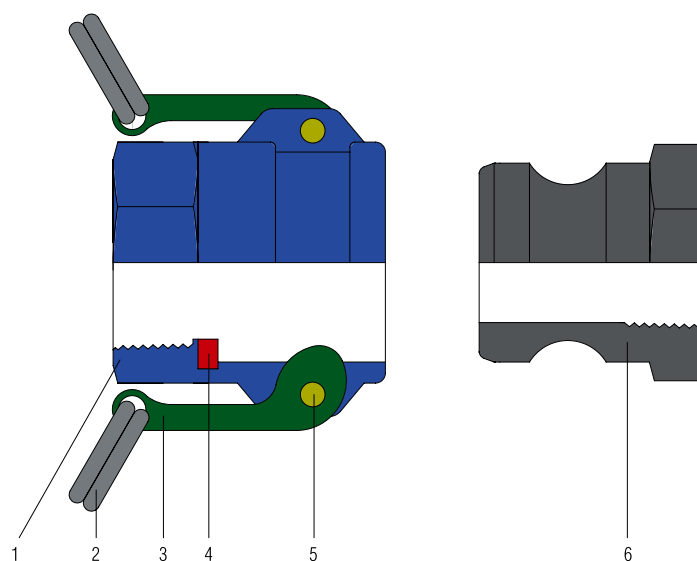

	項次 Item	零件名稱 Components	材質 Material	
母體 Coupler	1	母體本體 Coupler Body	SS316 / SS304 / 鋁 / 砲金銅 / 塑膠 SS316 / SS304 / Aluminium / Bronze / Polypropylene	
	2	環 Ring	SS304	
	3	柄 Arm	SS304	
	4	墊片 Gasket	標準 Standard	NBR
			其他選擇 Optional	EPDM / Viton / Silicone / Teflon (PTFE)
5	梢 Pin	SS303		
子體 Adapter	6	子體 Adapter	SS316 / SS304 / 鋁 / 砲金銅 / 塑膠 SS316 / SS304 / Aluminium / Bronze / Polypropylene	

扣鎖型有耳快速接頭

Camlock Quick Couplings

規格 Specifications

連接方式 Connection Type		外牙 / 內牙 / 膠管 / 塞頭 Male Thread / Female Thread / Hose Shank / Dust Cap			
尺寸 Size		1/2" ~ 2-1/2"	3"	4"	5"~6"
工作壓力 Working Pressure (kg/cm ²)	SS316 / SS304 / 鋁 / 砲金銅 SS316 / SS304 / Aluminium / Bronze	10	8	6	5
	塑膠 Polypropylene	3	3	-	-
密封圈材質及工作溫度範圍 O-ring Material and Working Temperature Range	標準 Standard	Buna N (NBR): -20°C ~ +80°C (-4°F ~ +176°F)			
	其他選擇 Optional	Fluorocarbon FKM (Viton): -20°C ~ +180°C (-4°F ~ +356°F) Ethylene Propylene (EPDM): -40°C ~ +145°C (-40°F ~ +293°F) Silicone (Si): -70°C ~ +250°C (-94°F ~ +482°F) Teflon (PTFE): -25°C ~ +100°C (-13°F ~ +212°F)			
適用流體 Applicable Fluid		水 / 液壓油 / 粉末 / 空氣 / 蒸氣 Water / Hydraulic oil / Powder / Air / Steam			

- 同尺寸的母體和子體才能互換使用。
- 不同材質的密封圈和閘門墊片，對於化學藥劑的耐受度也不同。請依您使用的流體來選擇合適的墊片材質。
- Coupler can be used with indentical size adapter.
- The chemical resistance differ from the O-ring and Valve Packing materials. Select the material according to the fluid you use.

安全的產品選擇 Safety in Product Selection

管道系統設計師和使用者對於選擇產品負有全責。在選用產品時，需考慮到整體系統的設計、應用細節、材料兼容性、功能、充份的額定值、正確的安裝、操作和維護，以確保安全無故障的性能。

The system designer and user have the sole responsibility for selecting a product for their use. The total system design, application details, material compatibility, function, adequate ratings, proper installation, operation, and maintenance must be considered to ensure safe and trouble-free performance.

扣鎖型有耳快速接頭

Camlock Quick Couplings

型號編碼 Part Number Description

Q		S6		B				300		N		N	
產品大類 Classification		材質 Material		扣鎖型有耳快速接頭 Camlock Quick Couplings				接口尺寸 Connection Size		螺紋種類 Thread Type		墊片材質 Packing Material	
Q	快速接頭類 Quick Couplings	S6	SS316	母體 Coupler		子體 Adapter		英制 Fractional		R	BSPT 牙 BSPT Male Thread	N	丁腈橡膠 NBR
		S4	SS304	B	外牙型 Male Thread	F	外牙型 Male Thread	050	1/2"	N	NPT 牙 NPT Male Thread	V	氟橡膠 Viton
		AL	鋁 Aluminium	D	內牙型 Female Thread	A	內牙型 Female Thread	075	3/4"			E	三元乙丙橡膠 EPDM
		BR	砲金銅 Bronze	DC	塞頭型 Dust Cap	DP	塞頭型 Dust Plug	100	1"	S	矽橡膠 Silicon		
		PP	塑膠 Polypropylene	C	膠管型 Hose Shank	E	膠管型 Hose Shank	125	1-1/4"	T	聚四氟乙烯 Teflon (PTFE)		
								150	1-1/2"				
								200	2"				
								250	2-1/2"				
								300	3"				
								400	4"				
						500	5"						
						600	6"						

Camlock

母體 Coupler

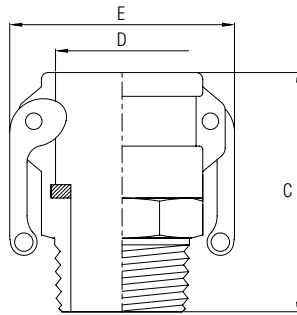

外牙型
Male Thread

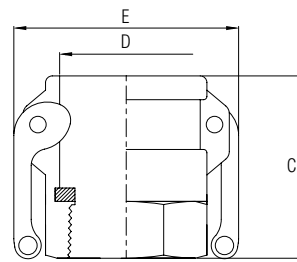

內牙型
Female Thread

	接口型式 End Connection	尺寸 Size	產品編號 Part No.	尺寸 Dimensions (mm)		
				B	φD	E
B	外牙型 Male Thread	1/2"	B050 □	47	25	44
		3/4"	B075 □	51	32	53
		1"	B100 □	60	37	61
		1-1/4"	B125 □	70	46	83
		1-1/2"	B150 □	72	54	91
		2"	B200 □	77	64	101
		2-1/2"	B250 □	85	76	113
		3"	B300 □	89	92	138
		4"	B400 □	93	120	167
		5"	B500 □	96	146	192
D	內牙型 Female Thread	1/2"	D050 □	48	25	44
		3/4"	D075 □	50	32	53
		1"	D100 □	58	37	61
		1-1/4"	D125 □	64	46	83
		1-1/2"	D150 □	68	54	91
		2"	D200 □	72	64	101
		2-1/2"	D250 □	77	76	113
		3"	D300 □	89	92	138
		4"	D400 □	94	120	167
		5"	D500 □	96	146	192
		6"	D600 □	108	177	236

- Fill the □ with thread type: "R" for BSPT and "N" for NPT.
- Only socket and plug with identical size are able to connect with each other
- Dimensions are for reference only, and are subject to change without notice.

- 在 □ 中填入螺紋種類：BSPT 牙請填 "R"、NPT 牙請填 "N"
- 只有同尺寸的母體和子體才能一起使用
- 尺寸僅供參考，修改恕不另外通知

Camlock

母體 Coupler

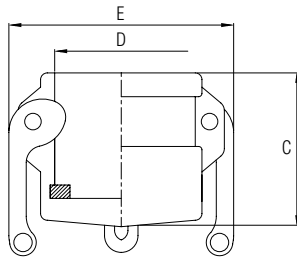

塞頭型
Dust Cap

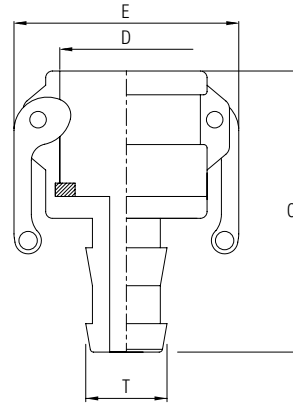

膠管型
Hose Shank

	接口型式 End Connection	尺寸 Size	產品編號 Part No.	尺寸 Dimensions (mm)		
				C	φD	E
DC	塞頭型 Dust Cap	1/2"	DC050	32	25	44
		3/4"	DC075	35	32	53
		1"	DC100	40	37	61
		1-1/4"	DC125	46	46	83
		1-1/2"	DC150	48	54	91
		2"	DC200	50	64	101
		2-1/2"	DC250	55	76	113
		3"	DC300	57	92	138
		4"	DC400	57	120	167
		5"	DC500	59	146	192
		6"	DC600	63	177	236

	接口型式 End Connection	尺寸 Size	產品編號 Part No.	尺寸 Dimensions (mm)			
				C	φD	E	T
C	膠管型 Hose Shank	1/2"	C050	67	25	44	15
		3/4"	C075	85	32	53	22
		1"	C100	97	37	61	28
		1-1/4"	C125	103	46	83	34
		1-1/2"	C150	108	54	91	41
		2"	C200	122	64	101	54
		2-1/2"	C250	138	76	113	67
		3"	C300	158	92	138	76
		4"	C400	165	120	167	102
		5"	C500	182	146	192	128
		6"	C600	204	177	236	156

- Only socket and plug with identical size are able to connect with each other
- Dimensions are for reference only, and are subject to change without notice.

- 只有同尺寸的母體和子體才能一起使用
- 尺寸僅供參考，修改恕不另外通知

Camlock

子體 Adaptor

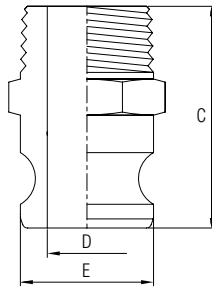

外牙型
Male Thread

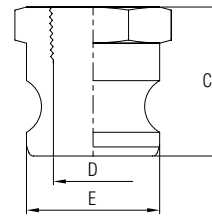

內牙型
Female Thread

	接口型式 End Connection	尺寸 Size	產品編號 Part No.	尺寸 Dimensions (mm)		
				C	φD	E
F	外牙型 Male Thread	1/2"	F050 □	53	14	24
		3/4"	F075 □	55	21	32
		1"	F100 □	66	25	37
		1-1/4"	F125 □	78	30	45
		1-1/2"	F150 □	78	39	53
		2"	F200 □	85	48	63
		2-1/2"	F250 □	100	60	76
		3"	F300 □	100	74	92
		4"	F400 □	108	102	120
		5"	F500 □	111	126	146
A	內牙型 Female Thread	1/2"	A050 □	38	14	24
		3/4"	A075 □	38	21	32
		1"	A100 □	46	25	37
		1-1/4"	A125 □	53	30	45
		1-1/2"	A150 □	53	39	53
		2"	A200 □	61	48	63
		2-1/2"	A250 □	77	60	76
		3"	A300 □	72	74	92
		4"	A400 □	75	102	120
		5"	A500 □	78	126	146
		6"	A600 □	84	152	176

- Only socket and plug with identical size are able to connect with each other
- Dimensions are for reference only, and are subject to change without notice.

- 只有同尺寸的母體和子體才能一起使用
- 尺寸僅供參考，修改恕不另外通知

Camlock

子體 Adaptor

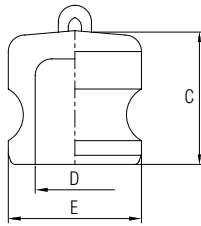

塞頭型
Dust Cap

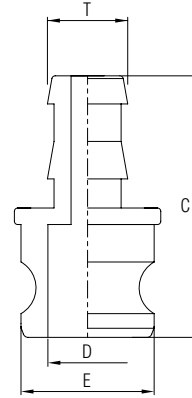

膠管型
Hose Shank

	接口型式 End Connection	尺寸 Size	產品編號 Part No.	尺寸 Dimensions (mm)		
				C	φ D	φ E
DP	塞頭型 Dust Cap	1/2"	DP050	38	14	24
		3/4"	DP075	38	21	32
		1"	DP100	44	25	37
		1-1/4"	DP125	51	30	45
		1-1/2"	DP150	51	39	53
		2"	DP200	60	48	63
		2-1/2"	DP250	63	60	76
		3"	DP300	68	74	92
		4"	DP400	67	102	120
		5"	DP500	79	126	146
		6"	DP600	85	152	176

	接口型式 End Connection	尺寸 Size	產品編號 Part No.	尺寸 Dimensions (mm)					
				C	φ D	φ E	T		
E	膠管型 Hose Shank	1/2"	E050	72	14	24	15		
		3/4"	E075	89	21	32	22		
		1"	E100	106	25	37	28		
		1-1/4"	E125	110	30	45	34		
		1-1/2"	E150	112	39	53	41		
		2"	E200	130	48	63	54		
		2-1/2"	E250	141	60	76	67		
		3"	E300	165	74	92	76		
		4"	E400	178	102	120	102		
		5"	E500	187	126	146	128		
				6"	E600	210	152	176	156

- Only socket and plug with identical size are able to connect with each other
- Dimensions are for reference only, and are subject to change without notice.

- 只有同尺寸的母體和子體才能一起使用
- 尺寸僅供參考，修改恕不另外通知

